

VANQUISH SYSTEM WITH DOWN JETS

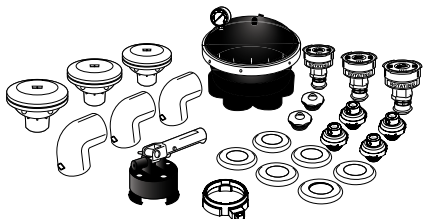

VANQUISH SYSTEM WITH DOWN JETS



AUTOMATIC IN-FLOOR CLEANING
& CIRCULATION SYSTEM
INSTALL MANUAL

NOTICE

To Installers: Read and follow these instructions. Give these instructions to the facility owner to keep for future reference. Follow all codes and regulations that apply to the design, installation and use of suction outlet fittings.



WARNING

MDX-R3 and SDX2 must be installed in accordance with Paramount's written instruction manual, and in conformity with applicable Federal, State, Local and Swimming pool industry building and safety codes.



FROM THE WORLD'S #1 IN-FLOOR CLEANING SYSTEMS COMPANY

US and Foreign patents and patents pending see
<http://www.1paramount.com/about/patents.php>



004-027-8714-00 ECN1433 R01 PUB 01/31/18

295 East Corporate Place • Suite 100 • Chandler, AZ 85225
Toll Free: 1.800.621.5886 • Phone: 480.893.7607 • Fax: 480.753.3397
Paramount@1Paramount.com • www.1Paramount.com

Signal Words and Symbols Used In This Manual

This Owner's Manual and Installation Guide contains specific precautions and symbols to identify safety-related information. You will find DANGER, CAUTION, WARNING and NOTICE symbols which require special attention. Please read them carefully and follow these precautions as indicated! They will explain how to avoid hazards that may endanger you or persons using or maintaining your pool or spa.



DANGER

DANGER indicates a hazardous situation which, if not avoided, will result in death or serious injury.



WARNING

WARNING indicates a hazardous situation which, if not avoided, could result in death or serious injury.



CAUTION

CAUTION indicates a hazardous situation which, if not avoided, could result in minor or moderate injury.

NOTICE

NOTICE is used to address practices not related to physical injury.

PLEASE REVIEW THE OWNER'S MANUAL AND INSTALLATION GUIDE IN ITS ENTIRETY AND HEED ALL SAFETY INFORMATION. Failure to follow these instructions and warnings can result in DEATH OR SERIOUS INJURY.

SUCTION ENTRAPMENT HAZARD:



DANGER

DEATH or SERIOUS INJURY will result if a drain cover or grate is not installed and used correctly.

- Pool and spa pumps produce high levels of suction and move high volumes of water, which can cause death or serious injury if a person comes in close proximity to pool or spa drains.
- Keep clear of pool and spa drains to avoid death or serious injury from suction.



DANGER

DEATH or SERIOUS INJURY will result from hair entanglement or limb entrapment.

- Keep clear of pool and spa drains.
- Hair sucked into pool or spa drains will tangle and knot trapping the swimmer underwater. Avoid placing your hair near a pool or spa drain.
- Avoid sitting on pool or spa drains because the suction can cause severe intestinal damage, evisceration, and/or disembowelment.



DANGER

DEATH or SERIOUS INJURY will result from pool or spa drain covers or grates that are improperly installed, missing, clogged, or broken.

- Inspect pool and spa before each use to ensure that drain covers and grates are properly in place and secured.
- Ensure that drain covers are not damaged, cracked, broken, loose, clogged, not properly secured, or missing because these conditions increase the chance of death or serious injury from entrapment.
- If a drain cover is discovered damaged, cracked, broken, loose, clogged, not properly secured, or missing, you should:
 - Close the pool or spa immediately; and,
 - Post a closure notice and keep the pool or spa closed until an appropriate ANSI/APSP -16-2011 certified drain cover is properly installed.



DANGER

DEATH or SERIOUS INJURY will result from contact with a damaged, loose, or missing drain cover.

- Do not allow limbs to contact or be inserted into a drain pipe with a damaged, loose, or missing drain cover. This could result in swelling of the limb and/or trapping a swimmer underwater.
- Avoid mechanical entrapment of jewelry, swimsuit, hair decorations, finger, toe, or knuckle in a drain pipe with damaged, loose, or missing drain cover. This may result in trapping a swimmer underwater.
- Do not allow body to come into contact with a drain pipe that has a damaged, loose, or missing drain cover. This may result in trapping a swimmer underwater.

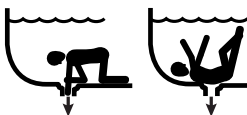

MAINTENANCE INSTRUCTIONS & WARNINGS:



WARNING

DEATH or SERIOUS INJURY can result from pool or spa drain covers or grates that are clogged by debris.

- All pool and spa drain covers may become obstructed by debris and should be cleaned periodically due to clogging from debris, such as pieces of plastic, hair, fabric, twigs, leaves, seeds, etc.
- The frequency of periodic cleaning will vary depending on the amount and type of debris introduced into the pool or spa
- Clogging of the drain cover will increase the suction effect and increase the likelihood of death or serious injury from those hazards listed above.
- A clogged drain can negatively affect the safety of the drain.
- It is advisable to have a qualified pool or spa professional perform this inspection and debris removal from the pool and spa drain covers.
- When servicing the drain cover, the pump connected to the suction must be turned off.
- Do not perform any service of the drain cover in water level above your waist.
- Use drain covers only with a pumping system rated for the corresponding flow or less. Failure to do so can result in hair or body entrapment which can cause death or serious injury. If in doubt about the rating of your system, consult a qualified pool or spa professional.
- Use only the supplied stainless-steel screws with the drain cover. Screws put into the frame anywhere except in the original screw holes will not hold and will allow the drain cover to come off the main drain, causing an entrapment hazard. If a screw hole(s) is stripped, inserts missing, loose, or damaged, consult your owner's manual and installation guide for proper steps to replace, correct, or reattach the compromised drain or drain component.



WARNING

Suction can pose a serious hazard to swimmers just as electricity can be a hazard. Both are important for proper water filtration and both must be treated with respect. Suction safety begins with a professional design that includes a quality suction system installed by a certified contractor.

Certified builders will address the following issues when designing and installing a proper filtration system:

- Properly bond-grounded pumps, time clocks, switches and any other metal in or near water. This is required to address Electrical Shock Hazards.
- Design the suction piping so there are no single-point suction hazards; single-point suction (one drain) is a leading cause of Body Suction Entrapment Hazards. Note: your certified builder has many effective options for addressing this hazard; they may include dual-drain systems, like MDX-R3, skimmers, gutters, negative edge features and many more products and piping designs known to professionals.
- Install ANSI/APSP - 16 - 2011 listed drains, suction covers and debris removal systems. This is the **ONLY** approved option for preventing Hair Entrapment Hazards, the leading cause of suction related injuries.
- Design and install an effective circulation system (including optional cleaning systems), to direct filtered water to all areas and interior surfaces. **NOTE:** Suction fittings can **NOT** clean or direct filtered water for proper sanitation; that can only be done on the pressure (return) side of the filtration system.

While suction injuries are extremely rare, drowning and diving injuries are far too common and there is little your certified builder can do to eliminate these hazards. You must educate yourself and your guests. Below are some important safety issues every swimmer must know and recognize.

- **PREVENT DROWNING:** Watch children at all times, no swimming alone.
- **NO DIVING IN SHALLOW WATER:** You can be permanently injured.
- **PREVENT SUCTION ENTRAPMENT:** Inspect suction covers before swimming, keep swimmers away from suction fittings, protect long hair, don't swim with loose clothing or large and dangling jewelry.

For more information about the Virginia Graeme Baker Pool and Spa Safety Act, contact the Consumer Product Safety Commission at (301) 504-7908 or visit www.cpsc.gov.



WARNING

Always turn off all power to the pool pump before installing the cover or working on any suction outlet.

TABLE OF CONTENTS

VANQUISH EQUIPMENT REQUIREMENTS/OPTIONS5

VANQUISH CAD LAYOUT SERVICE7

DIMENSIONED NOZZLE PLACEMENT DRAWING8

VANQUISH PLUMBING DETAIL.....8

PLUMBING FEED LINES/BODY9

2" VALVE BASE PLUMBING GUIDE10

CANISTER PLUMBING DETAIL & PRESSURE TEST11

POOL DRAIN SYSTEM.....12

VANQUISH FLOOR BODY INSTALLATION12

MODULE INSTALLATION & START UP.....14

VANQUISH NOZZLE INSTALLATION.....15

DOWN JETS INSTALLATION.....16

SWINGJET INSTALLATION17

WINTERIZING INSTRUCTIONS.....19

WATER VALVE.....20

SYSTEM START-UP.....21

TROUBLE SHOOTING.....21

WATER VALVE PART NUMBERS23

VANQUISH PART NUMBERS24

VANQUISH EQUIPMENT REQUIREMENTS/OPTIONS

Vanquish System

single pump requirements

Selecting Proper Pump Size

1. Determine GPM and Ft./Hd. requirements from In-Floor System Specification Chart below.
2. Refer to manufacturer's pump curve of equipment you use.
3. Compare Part # and Model #. Do not rely on horsepower. Most manufacturers make both full-rated and up-rated pumps. This also relates to low and high service factors.
4. Most pump curves will show Total Head in Feet on the left side vertically. Gallons per Minute are indicated horizontally across the page.
5. Draw an X where the two lines intersect. This will give you the pump required.

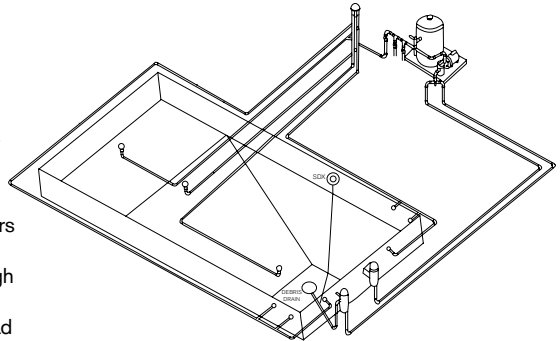

IN-FLOOR SYSTEM SPECIFICATION CHART

Single Pump
+50 GPM @ 70 TDH
Filter/Cleaner Pump

Min. Filter
4.9 Sand
48 sq. ft. D.E. 200+ sq. ft. Cartridge
No 1 1/2" multi-port filter valves by-pass
required on a heater

- Any time the equipment is more than 50 ft. away from skimmer, special engineering is required. Submit a copy of the proposed plan indicating the specific information to Paramount Pool & Spa Systems.
- GPM stated are the requirements of the in-floor system. Additional equipment such as chlorine generators, spa overflows, etc., require more water flow. Adjust pump GPM requirements accordingly.

Filter requirements: Selecting proper filter size

When selecting filter sizes, if the filter requirements fall in between available sizes, select the next larger filter. Refer to Equipment Spec Chart for required rate.

NOTE: Filter rates in excess of 20 GPM per sq. ft. can cause channeling of the filter bed.

NOTE: Excess flow rates can cause the fibers of a cartridge to become impacted.

SwingJets™ (not used in collection zone)

SwingJets™ are specially designed return fittings that fit into standard 1 1/2" threaded sockets. They provide better control of water flow as opposed to conventional wall returns. The jets are positioned at the back and side walls of deep-end pools to sweep debris toward the main drain. SwingJets are designed to deliver an infinitely adjustable 3-step 90° cleaning arc with an innovative automatic reversing mechanism.

SwingJet™
THE WALL RETURN & DEEP END CLEANER



DOWN JETS



The Down Jets (must be used in collection zone)

Provide Several Functions:

- Create flow influence pattern towards main drain for debris removal
- Clean out dead areas

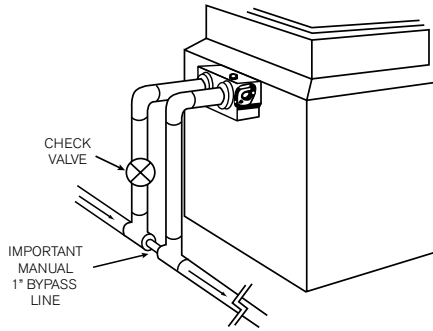
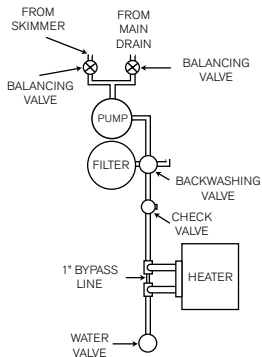

HEATERS

When installing a heater on the pool, a 1" BY-PASS TO PARTIALLY DIRECT WATER AROUND THE HEATER IS NECESSARY. This allows part of the water through the heater for heating but limits the head loss created when all the water is directed through the heater.

THE IN-FLOOR SYSTEM WILL NOT FUNCTION PROPERLY WITHOUT THIS BY-PASS.

If the Vanquish System has a booster pump the heater does not require an external by-pass

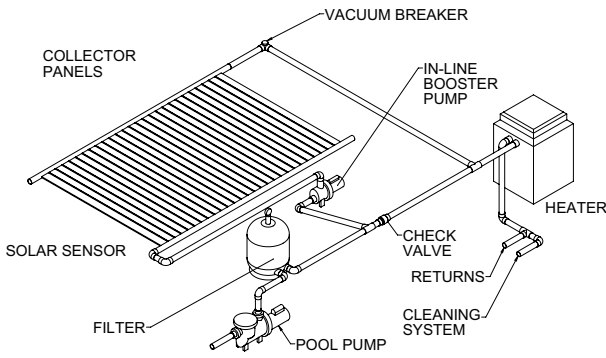

POOL SYSTEM

SOLAR SYSTEMS

Paramount recommends solar systems be operated independently with a booster pump, separate suction, and returns, or as shown below with a secondary booster pump, and the in-floor system valve installed after the solar and heater pack.

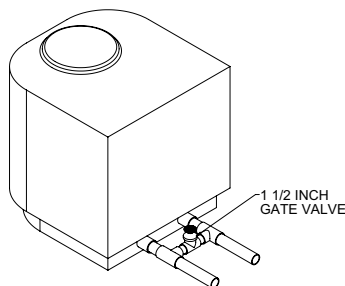

HEAT PUMP

Heat pumps must have a minimum by-pass of 1 1/2" with a gate valve for adjustment. The gate valve must be set with a temperature probe to factory specs for heat rise.

VANQUISH CAD LAYOUT SERVICE

Paramount's Electronic Imaging System Design Service has emerged as a vital component in providing Vanquish Dealers with 48-hour Vanquish system layout.

PLEASE NOTE: Paramount desires to design your system for maximum performance with the least amount of product investment. If the layout returned does not represent the pool or the pool changes shape during construction, contact Paramount immediately to maintain cleaning guarantee.

IT'S EASY TO USE THE VANQUISH EMAIL SYSTEM

1. To get a copy of the Vanquish Drawing Request Form go to www.1paramount.com. Download and complete the form. After completing, save form and email the form to our CAD department at cad@1paramount.com.
2. Provide a 1/8"-1" scale print of pool design including
 - Any floor transition and the shape
 - Main Drain location
 - Detailed drawing of steps, benches and swim-outs
 - Location or distance of equipment from pool
3. Email to cad@1paramount.com or fax to 480.893.7621.

Drawing Request Form

Please Allow 2 Business Days For Layout



Toll Free: 1-800-821-2888
 Phone: 480-893-7627
 Fax: 480-893-7621
www.1paramount.com
 REV: 04/26/14

If You Would Like Information On E-Mailing Drawings Please E-Mails Us At cad@1paramount.com

Company: Title:

City: State: Zip:

Contact Name:

Telephone:

E-mail: pdf dwg

Fax: Yes No

Revisions

Previous Drawing #:

What is Revised:

Length-Width Measurements, Breakline & Drain Location Must Be Shown On A Scaled Pool Drawing

Pool Dimensions: x Pool Depth: Pool Breakline: x

"Check Corresponding Boxes And Fill In The Blanks To Best Describe The Cleaning System Requested"

Power: 110V 220V 240V

For Cleaning System: Pool & Spa Hot Tub Hot Tub/Spa Hot Tub/Spa/Pool

Standard Cleaners In Storage: Standard Standard & Downspout Hybrid System Step & Bench Noises

Drains / Cleaners / Skimmers				Ancillary Products (Optional)			
Model	Cleaner	Canister w/SPS	Canister w/SS	Ultra UV Water Sanitizer	120V	220V	Number of Lanes
Pool	<input type="checkbox"/>	<input type="checkbox"/>	<input type="checkbox"/>	Yes	<input type="checkbox"/>	<input type="checkbox"/>	<input type="checkbox"/>
Spa	<input type="checkbox"/>	<input type="checkbox"/>	<input type="checkbox"/>	Yes	<input type="checkbox"/>	<input type="checkbox"/>	<input type="checkbox"/>
Basin	<input type="checkbox"/>	<input type="checkbox"/>	<input type="checkbox"/>	Parasol	<input type="checkbox"/>	Perimeter	Wearhead
Standard Skimmer	<input type="checkbox"/> etc.	Venturi Skimmer	<input type="checkbox"/> etc.				

NOTES:

Customer Service Product Ordering Section

Completing this section will result in an order being processed and product being shipped based on the bill of materials in the drawing.

Color Selections

Headler/Drain/Paramount: White-01 Gray-02 Black-03 Teal-04 Blue-05 Light Blue-06 Bronze-07 Light Gray-08

Canister/Parasol/Lite: White-01 Gray-02 Teal-04 Blue-05 Light Blue-06 Bronze-07 Light Gray-08

Shipping Priority: Standard 1-Day Next Day AM Next Day PM Next Call Click

** In order to receive a quote you must email paramount@1paramount.com and provide them with the drawing number on your plan!

NOTES:

To insure incentive points are awarded accurately be sure to fill out the pool builder information completely

For the most current version, download Vanquish Drawing Request Form at www.1paramount.com/

DRAWING

- ROTATING NOZZLE
- STEP NOZZLE
- SPINNING NOZZLE
- 6-PORT VALVE
- 9-PORT VALVE
- 12-PORT VALVE
- 24-PORT 4-GEAR
- MDX-R3
- CANISTER
- DOWNNET
- SWINGNET
- BLEEDOFF
- CANISTER W/INFLATE
- IMPERF DECOMPACT
- CLEANER
- AIRPORT
- SS 2-INCH
- PARALLEL
- PARACAPTE
- JETPACK
- NIAGARA WATERFALL
- CENTURION SKIM

1/8" JET	1/2" JET	3/8" JET	1/4" JET
1	1	1	1
2	1	1	1
3	1	1	1
4	1	1	1
5	1	1	1
6	1	1	1

"The 99% Cleaning Guarantee will only apply to AREAS of the pool and / or spa equipped with an MDX-R3 and cleaning nozzles on the floor, steps, benches, sun decks, catch basins or any other design features of the pool or spa, and must be built to the specifications of this layout."

Order

CUSTOMER:

COMPANY:

CITY:

STATE:

ZIP:

DATE:

ORDER:

SHEET:

INSTR:

DATE:

STATE:

ZIP:

DRAWN BY:

APPROVED BY:

Paramount

Pool & Spa Services

480.893.7627 fax: 480.893.7621

800.621.5885 cad@1paramount.com

NOTE: MDX-R3, MDX4 and SKIM MUST BE INSTALLED IN ACCORDANCE WITH PARAMOUNT'S WRITTEN INSTRUCTION MANUAL, AND IN CONJUNCTION WITH APPLICABLE FEDERAL, STATE, LOCAL AND SWIMMING POOL INDUSTRY BUILDING AND SAFETY CODES.

THIS DRAWING IS FOR PURPOSE OF IN-FLOOR LAYOUT ONLY

NOTE: LOCATION OF CANISTER, SKIMMER AND SECTION OF SECTION OPTIONAL. ALL PERMITS OBTAINABLE FROM APPROVED LOCAL AGENCIES. SHOWN AND NOTED THEREIN.

*Only one Skimmer to be used on a single spa system.

*Heater must have bypass

*No 1 1/2" multiple ball valves

DIMENSIONED NOZZLE PLACEMENT DRAWING

After the nozzle placement has been determined, a scaled drawing should be made with dimensions clearly indicated. The dimensioned drawing should be the plumber's guide and part of the superintendent's checklist to insure proper placement.

As stated earlier, proper nozzle location is critical. Should the pool's configuration change (i.e., step location, break location, overall dimension), the nozzle placement must also change. A revised plan must be drawn. Choose one nozzle to use as a starting point and indicate dimensions to outer walls. This will enable the plumbers to find location of first nozzle and then use triangulation to locate the remaining ones.

Vanquish pool with SwingJet option

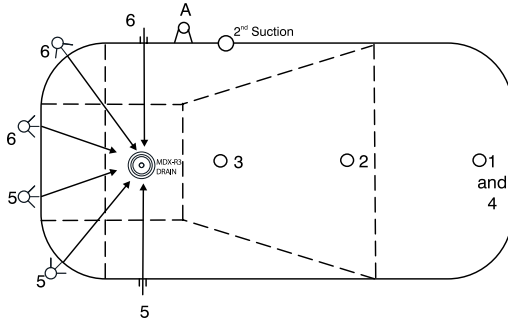

VANQUISH PLUMBING DETAIL

Vanquish pools with downjet option

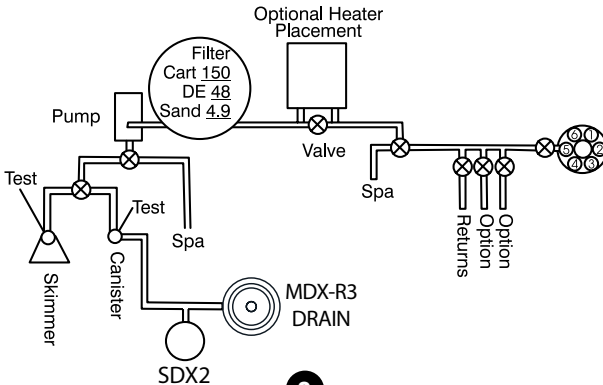
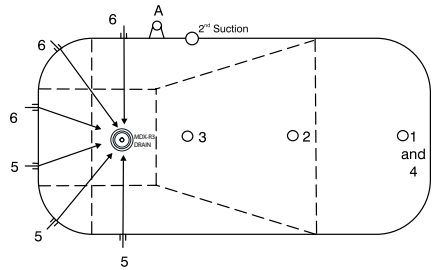
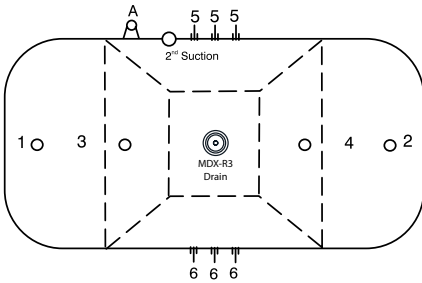

PLUMBING FEED LINES/BODY

Using the dimensioned layout plan, drive a stake into the exact location of each nozzle. Please note that dimensions indicate from finish, not excavation. Allow for thickness of wall. Use Sch40 PVC pipe for all the system plumbing. **Do not use flex PVC pipe or poly pipe for the Vanquish System.** Use 45-degree fittings instead of 90-degree fittings whenever possible or when practical.

NOTICE WHEN PLUMBING THE WATER VALVE: All pipe fittings **MUST** be staggered (see figures on page 9). All plumbing should be 2".

The feed lines are to be 2" PVC. Paramount recommends the lines enter at the center of length of pool. Excavate a niche to the bottom of pool depth at this location. This large niche allows ample room for the feed lines. There are occasions when it may be advantageous to feed part of the lines in places other than the center. The lines feed the individual zones of nozzles. At each nozzle location, install a 2" 90-degree elbow. Glue the body into the elbow. The Paramount Vinyl Body Requires the Installation of a Concrete Base Surrounding the Body as Illustrated Below.

Whether the pool base is packed with vermiculite or concrete, the vinyl body must be encased in concrete as shown. Plug all lines and pressure test to a minimum of 25 psi. Install the pressure-testing device at the equipment header.

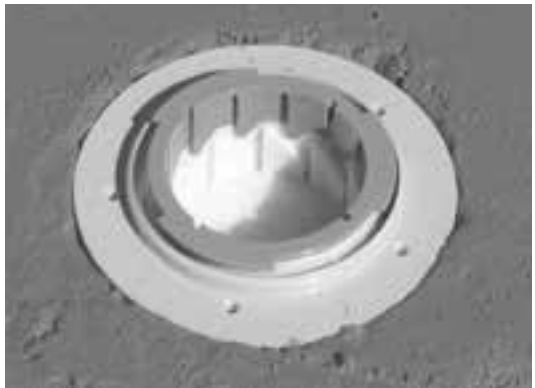

Available separately
Vanquish Floor Body Pressure Test Plug - #004-577-1632-00
Vanquish Step Body Pressure Test Plug - #004-552-1642-00

2" VALVE BASE PLUMBING GUIDE

NOTICE: All pipe fittings MUST be staggered. All plumbing should be 2".

The water valve is normally set 6" above water level in a convenient location poolside. This results in dramatic reduction in plumbing runs and increased cost savings.

The center port of the bottom housing is the inlet to the valve. Cut all pipes square, this allows maximum gluing surface to the bottom housing. **USE PRIMER AND GLUE ON BOTTOM HOUSING AND ON PVC PIPES.** (IPS WELDON 2943 PRIMER and 1007 GLUE or 4052 GLUE or EQUIVALENT)

Glue pipe all the way into the stop and allow at least 24 hours drying time before pressure test. To prevent glue damage to internal ribs always glue with the valve right side up and pipes facing down.

If not all six (6) ports are required, use one of the ports twice to feed one return line. The common ports should not be plumbed next to each other, always skip a port when double firing. The pipes from the water valve should be connected together underground.

Gluing Instructions:

1. Remove Clamp
2. Lift off dome (save O-ring)
3. Remove pressure gauge and T-handle from inside valve housing assembly.
4. Pipes and valve base should be treated with primer.
5. Make sure pipes are glued all the way into the stop. Be careful not to allow glue to run into module area.*
6. The center port is the inlet to the valve and should be approximately 3" longer than the perimeter pipes.
7. Allow 24 hour before pressure testing.
8. Reposition o-ring in groove in the valve base.
9. Replace dome and V-Clamp and tighten until snug.
10. Thread the pressure gauge to the top of the dome. **DO NOT USE TEFLON TAPE**
11. Pressurize with pool plumbing (do not exceed 35 psi.)
12. Store the module assembly in a safe place and install after the pool has been started up.

* Pipes should be a minimum of 12" in length and should insure the valve be at least 6" above water level

PARTS NEEDED FOR ASSEMBLY

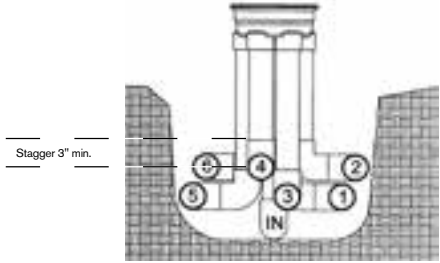

OPTION ONE

- (3) 2"X12" PVC PIPE (port 2,4,6)
- (3) 2"X15" PVC PIPE (port 1,3,5)
- (1) 2"X18" PVC PIPE (port inlet)
- (4)2"X2 1/4" PVC PIPE (port 1,2,5,6)
- (11) 2" SLIP 90° ELBOWS
- Optional: replace (4) 90° elbows and (4) 2"x2 1/4" pipes with (4) spigot 90° elbows
- Set in trench 15" deep X 19" wide

NOTE: Height of riser pipes may be adjusted as long as the 3" height differential between fittings is maintained.

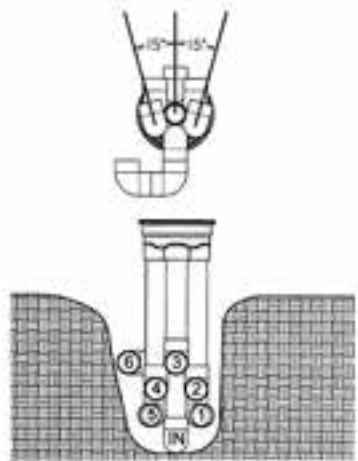

OPTION TWO

- (2) 2"X12" PVC PIPE (port 3,6)
- (2) 2"X15" PVC PIPE (port 2,4)
- (2) 2"X18" PVC PIPE (port 1,5)
- (1) 2"X21" PVC PIPE (port inlet)
- (2) 2"X2 1/4" PVC PIPE (port 6)
- (8) 2" SLIP 90° elbows
- Optional: replace (2) 90° elbows and (2) 2"x2 1/4" pipes with (2) spigot 90° elbows (port 6)
- Set in trench 19" deep X 12" wide

IMPORTANT: PORT 1 AND 5 MUST BE SET AT 15" OFF CENTERLINE IN ORDER TO CLEAR

CANISTER PLUMBING DETAIL & PRESSURE TEST

The DDC2 patented debris canister is unique in that the lid is a water sealed lid. **NOTE; Because of this the canister has a socket for a 1½" equalizer line that must be plumbed through the pool wall with a 1½" straight pipe.**

There are two other sockets one on each side of the equalizer line. One is 3" and the other is 2". One of these is for the main drain line and the other normally gets plugged off. On the bottom there is one 3" socket that goes to the suction of the pump. We recommend a nipple and a cap be used to plug of lines.

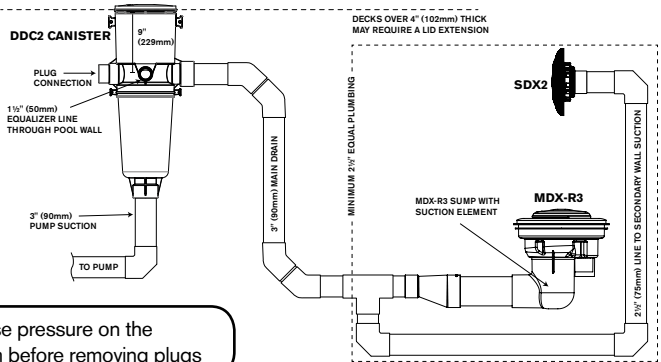

WARNING

Release pressure on the system before removing plugs

Pressure Test Detail

- Pressure should remain on the system through construction until interior cleanup.
- Use reversible ratchet to install test plugs, 15/8" or 12 pt. socket 2A406

NOTICE

Release pressure on the system before removing plugs

NOTE: A Nozzle Pressure Test Plug is available though Paramount if you need to pressure test system lines.

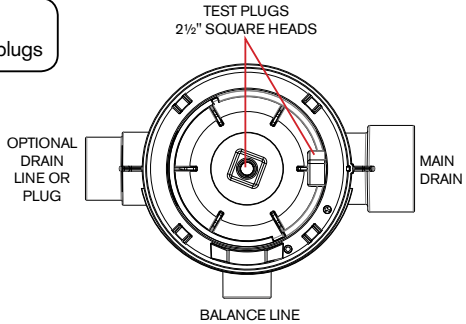
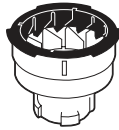

EXTRA LONG T-BAR HELPFUL FOR INSTALLATION



POOL DRAIN SYSTEM

If you use one of the Paramount MDX 'VGB Compliant Debris Drains' consult the applicable manual for specific instruction on how to plumb.

MANUAL PART NUMBERS: MDX-R3 Vinyl: 004-027-8820-00



DANGER

To avoid improperly installing the MDX-R3 drain, failure to do so will cause serious injury or death through entrapment, contact Paramount to schedule training at 1-800-621-5886 or email paramount@1paramount.com

NOTICE

To Installers: Read and follow these instructions. Give these instructions to the facility owner to keep for future reference. Follow all codes and regulations that apply to the design, installation and use of suction outlet fittings.



WARNING

MDX-R3 and SDX2 must be installed in accordance with Paramount's written instruction manual, and in conformity with applicable Federal, State, Local and Swimming pool industry building and safety codes.

VANQUISH FLOOR BODY INSTALLATION



Step 1: Before pouring concrete around the Vanquish body be sure the cap is on the body. Pour concrete in a 12" x 12" x 6" deep area and trowel smooth with the flange on the body, and the finish level of the vermiculite. Be careful not to get concrete in the screw holes.

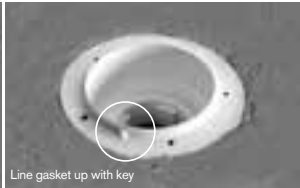

Line gasket up with key

Step 2: Remove cap and place one of the gaskets over the flange on the body being sure to line up the key. Some builders using heavier liners leave this gasket out and rely on the liner to be the bottom gasket.

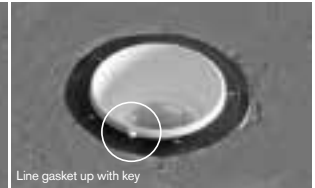

Line gasket up with key



Step 3: Install the liner and make sure it is smoothed from the main drain out past the area of the body you are working on. Put the second gasket and top body flange over the body (with the liner uncut) between the two gaskets. Be sure to line up the gaskets and top flange ring with the raised key in the body



Step 4: Screw down the flange, gasket, liner, and bottom gasket to the body making sure to screw in an across from each other pattern.



Step 5: Cut out the liner from the inside of the top hold down flange.

During installation of the liner, top flange, and gaskets, a sealant may be used on the mating surfaces of the assembly.

FLUSH ALL LINES PRIOR TO INSTALLATION OF CIRCULATION NOZZLES.

Important

For installation of step and bench nozzles refer to the Vanquish Step And Bench Nozzle Installation Guide #004-577-6437-00

START UP



1. Remove all pressure test plugs.



2. Install fine mesh bag and basket.

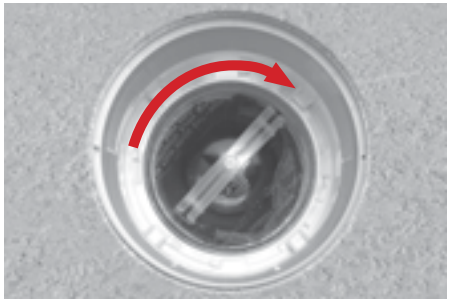

3. Insert lid assemble into canister. Turn lid assembly clockwise until it clicks into place on the retention stops.

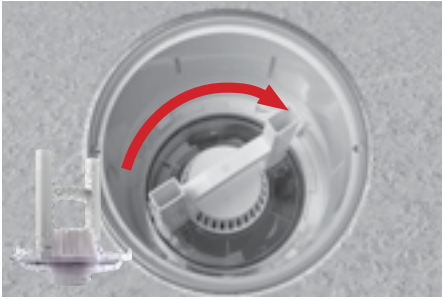

4. Insert Optional MVFUSE lid assemble into canister. Turn lid assembly clockwise until it clicks into place on the retention stops.



5. If the lid assembly is not held securely it will back out or bounce on startup causing the optional MVFUSE mechanism to open and cavitate the pump.

MODULE INSTALLATION & START UP

Before installing the module, startup the pump and run **WITHOUT THE MODULE IN PLACE** to clear any debris from the feed lines. After the module is installed and before installing the nozzles, run the water valve to clean out any debris in the cleaning circuits. If a circuit has more than one nozzle, alternate blocking off all but one nozzle on that circuit one at a time to clean out any debris. Use of the pause control will hold the valve on that port while doing this. The equipment needs to run for a minimum of ten minutes before installing the valve module.



1. Turn off the pump



2. Remove clamp and dome



3. Clean and install base o-ring



4. Set module into base



5. Turn module slightly until it sits in place lined up with guide pins



7. Turn water valve to "RUN" position



7. Place dome over module. Secure dome and base with band clamp



8. While tightening band clamp, lightly tap clamp with a screwdriver or wrench



9. Inspect for leaks

VANQUISH NOZZLE INSTALLATION

The rotating cleaning nozzles use 3/4" or 1/2" jets (vinyl install), depending upon location and required cleaning distance. The 1/2" nozzle insert is in the closed position when it is installed at the factory, with the nozzle being open on the 3/4" side. If the design sheet calls for 1/2" jets on some nozzles then follow the directions below.

On pool start-up, reference the system design detail sheet for the proper jets required for each zone. Prior to installation of the nozzles, install the water valve module and start equipment to flush out any remaining debris in the plumbing lines!



Step 1: The nozzles come from the factory with a 3/4" and a 1/2" jet. Only one jet will be open. Push up the nozzle and check to see which side is the open side, if you need to have the 1/2" side open and it is closed then go to Step 2.



Step 2: Hold the top of the body with the shaft that has a spring facing up. Turn the shaft counter-clockwise about 1/4 turn until it stops. Pull and jiggle the shaft (while continuing to hold the nozzle upside down. When it comes out, rotate the shaft 180° and put it back into the body and cap. Move it back and forth until you fill it start to go down.



Step 3: Push the shaft all the way into the body and cap and turn the shaft clockwise until it stops.



Step 4: Once the shaft is locked in place push it up and check to see the proper jet is now open and the other side is closed.

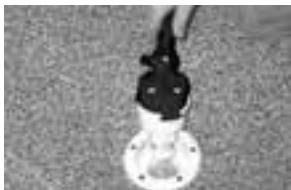

Step 5: Snap the nozzle onto the nozzle tool by twisting



Step 6: Install nozzle in body by turning counter-clockwise until snug

Step 7: Adjust the suction flow of the active main drain and skimmer lines so that 60% of the suction is from the main drain/canister.

DOWN JETS / SWINGJETS

The down jets are controlled by two circuits on Paramount's water valve.



DOWN JETS INSTALLATION

Paramount supplies special "down jet" eyeballs that adapt to many of the common wall return sockets. The installation of these down jets is essential for the operation of the System. Down jets are generally positioned as indicated in Fig. 1 & 2 or as indicated on the system design detail sheet. For increased cleaning of side walls SwingJets can be used instead of down jets in Fig. 3 & 4. SwingJets rotate back and forth and cover a 90° pattern.

NOTE THE DOWN JET EYEBALL

This special eyeball directs the flow of water down the sidewall towards the main drain. Based on the patterns shown in the diagrams, this design will help push debris to the main drain.

It is most beneficial that you show the pool owner each step of the start-up of the System. It is possible that swimmers could alter the system's positioning of the down jets, and gate valves. Showing the home owner how to position the down jets and providing the pool owner with the nozzle tool may prevent a future warranty call or complaint.

Proper Positioning Of Down Jet Eyeball



Fig. 1 - Deep-End Pattern

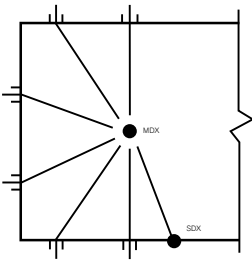

Fig. 2 - Center-Depth Pattern

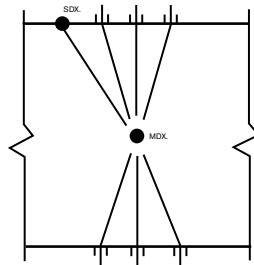

Fig. 3 - Deep-End Pattern with SwingJets

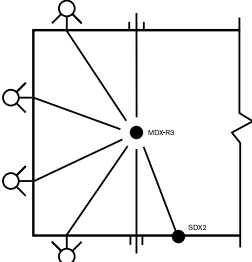
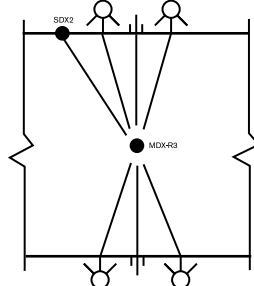

Fig. 4 - Center-Depth Pattern with SwingJets



SWINGJET INSTALLATION

The New SwingJet comes packed with the cover off.

- Push the nozzle up and look and feel for the raised area on the side of the colored nozzle that is in the center of the cream colored Cam. (Fig 1). The nozzle jet opening is 180 degrees opposite that raised area. Push the nozzle shaft up and down until the nozzle jet is either all the way right or all the way left so when you are doing the next two steps you are aware of which direction it is going to travel when rotating.
- There are three notches in the cream colored cam above the raised area (Fig 1). These cam notches are in a straight line with the cam notches on the opposite side of the raised area. The jet opening of the nozzle goes back and forth covering the 90 degree arc formed by the three ratchet positions as the nozzle extends and retracts when cycled.
- Put one wrap minimum of Teflon tape on the threads to make the nozzle threads not seize up over time, and thread the swing jet in the return fitting tight, using the swing jet installation and removal tool. It should be tight enough so it can not be turned by hand. Hand tighten only, NEVER USE A WRENCH DIRECTLY ON THE SWINGJET. ALWAYS REMOVE THE COVER AND USE THE TOOL (Fig 2 & 3) (AVAILABLE FROM PARAMOUNT 005-721-4541-00 included in the system) TO COVER THE SWINGJET RETAINER BEFORE USING A WRENCH TO REMOVE THE SWINGJET.
- Grasp the cream colored cam and turn it either way to aim the nozzle jet to clean the desired area. Remember the nozzle is going to ratchet right or left depending on which of the two side notches you placed the pins in. (Fig 1)
- After turning and adjusting the cam be sure that the ratchets in the cam are seated by gently rocking the cam right and left to make sure the ratchets are in the groove.
- Once in position find the clip on the outside ring of the nozzle retainer (Fig 4) and place the hole in the cover so it is just to the counter clock wise side of the retainer clip (Fig 4). Line up the notches on the cover with the locking cams on the nozzle retainer. Push the cover on to the retainer and rotate clockwise until the clip snaps in the hole (Fig 4). Do not force the cover on when not in position. It will be difficult to remove.

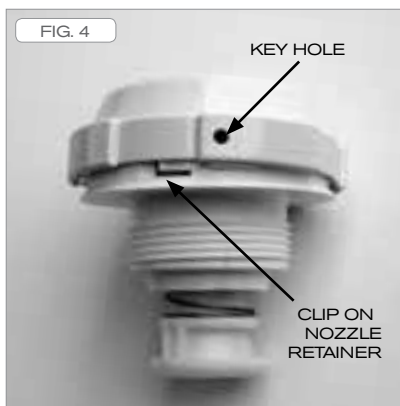
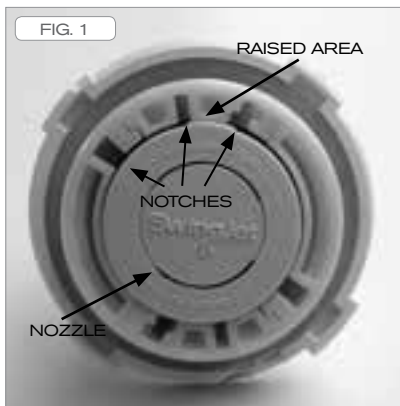

ADJUSTING A SWINGJET WHEN IT IS THREADED IN PLACE

- Turn the pump on so the SwingJet is on. If the SwingJet is on a water valve circuit, wait for the SwingJet to come on, and pause the water valve.
- Place the swing jet tool (Fig 2) provided with the unit (part # 005-721-4541-00) over the cover with the spring loaded key over the hole on the side of the cover of the SwingJet (Fig 5 & 6). Leaving the key in place, while pushing down on the button key rotate the cover counter clockwise until it stops. Do not remove the key. The extended nozzle should now be able to be rotated to the desired position. If the nozzle won't easily rotate remove the key and very slightly move the cover counter clock wise until the nozzle will rotate. Once the nozzle is set to the correct position, remove the key and rotate the cover clock wise to re-lock the cover in place.
- Cycle the SwingJet by turning the pump off and on to make sure you have set it in the desired position.

MULTI SPEED PUMPS

The Swing Sweep Jet/s may not retract or extend all the way on low speeds, but should start extending and retracting properly once the pump speed returns back to the high cleaning speed of 19 to 20 psi on the water valve or 25 psi or higher on the filter gauge on a clean filter if no water valve is used. The multi speed filter pump should run at the speed needed to produce at least 25 PSI on a clean filter for at least 2 hours for effective use of the SwingJet / Sweep system.

Note: Pools with cartridge filters, SwingJets are a precision ratcheting nozzle/s which reverses back and forth. It is important that when cleaning your filter you follow the steps below to eliminate debris from getting into the lines and equipment (including SwingJets, chlorinators, heaters, water features and water valves and back into the pool downstream from the filter).

1. Turn off the filter pump, open the filter air bleed at the top of the filter tank.
2. Open/remove the drain plug on the bottom of the filter (plumbing a two way valve to replace the plug can make this a time saving and easy thing to do).
3. Remove the lid from the filter. Using a hose, wash out the inside of the tank.
4. After the tank is clean, remove the filter elements and clean them thoroughly. Refer to the cartridge manufacturer's instructions for proper cleaning procedure.
5. When clean, replace the filter elements. Put the drain plug back / or turn off the two way valve (if installed), replace and seal the filter lid. Turn on the pump (never stand over any piece of equipment you have just worked on when turning on the pump). When water starts coming out of the air bleed close it.



WINTERIZING INSTRUCTIONS

Winterizing a Paramount Pool & Spa Systems Vanquish pool is the same as any pool with a main drain; it just has a few more lines to winterize. These procedures are to be used in addition to standard winterization methods normally used in your area.

To Do List:

- Store the Paramount valve module, canister inner lid and basket in a safe, dry place.
- Remove and store any SwingJets or downjets located above the freeze line.
- Blowout and airlock all pool lines.
- Remove all water from the canister and replace with swimming pool anti-freeze and an empty jug, the same way you winterize skimmers.

The following steps are procedures recommended for proper winterization of all Paramount In-Floor Cleaning Systems. These procedures do not replace normal winterization procedures but are instead in addition to them.

PARAMOUNT CANISTER WINTERIZATION

1. Remove outer lid, inner lid and basket, clean and dry off, and store in same area as modules
2. Install and secure regular winterization plug in equalizer line of canister to pool at pool side.
3. Install and secure Schrader plug or blow out plug from canister to main drain. Blow out and obtain air lock as previously described, if skimmer is tied into canister, repeat procedure to skimmer.
4. Bottom port of canister to pump may require an extended pipe for ease of blowing out. Install and blow out line from canister to pump. Install and secure plug in pump. Using a wet/dry shop vac, remove all water from within canister components.
5. Extension pipe can be removed and replaced with plug or Gizmo type container if Gizmo not used. Be sure to install device to absorb ice expansion in canister area. Failure to do this may result in potential ice freeze damage to canister.

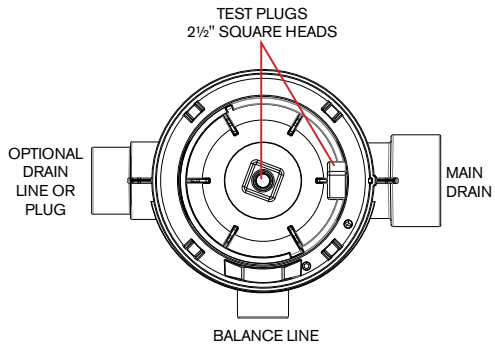

Winterization anti-freeze is to be used as necessary or when required.

WATER VALVE

1. Turn off and drain out all pool equipment.
2. Remove valve lid or lids from valve(s).
3. Remove module(s) from valve housing(s). Store module in dry clean area out of the winter elements for winter until re-installation in spring.
4. Remove any down jet returns and SwingJets in pool (threaded or slip) including down jet body for a secure fit of winterizing plug. Store with module(s).
5. From valves to pool, place a Schrader plug or blow out plug as recommended
6. Install and secure Schrader or blow out plugs in all parts of valve.
7. Proceed to blow out lines through Schrader or blow out plugs to pool.
8. While blowing out the in-floor nozzles, once a good amount of air has come through the nozzle, you have accomplished an air lock. (This procedure is similar to obtaining an air lock when blowing out the bottom drain in the pool.)
9. Blow out center port of first valve back to filter equipment and plug.
10. Repeat until all ports are blown out.
11. Step/bench heads or returns that are on a port of the water valve and are above the freeze line must be plugged off so the water does not travel back up the line. This is done by blowing out the port on the water valve and when air starts bubbling out the body/return fitting you must remove the head/return fitting and plug the fitting. Continue doing this until all but the last one on the line is either below the freeze line or blowing out air. Then put the standard expansion plug with a schrader valve that fits inside a 1½" schedule 40 pipe (available at your local distributor) in while having the air stop being injected into the line at the same time.
12. When necessary, pool winter anti-freeze solution should be poured into each line.
13. Valve housing(s) should be wiped clean and dry of water, reinstall top lid and secure.

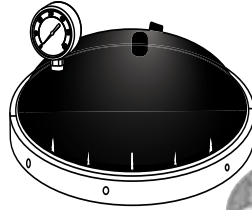

SYSTEM START-UP

GETTING STARTED

Note:

Installing the right size orifice in each nozzle is the key to proper operation.

This is a must for the pool to clean properly.

Remember to flush out the line on each zone, installing one complete zone of heads at a time.

Do not let valve cycle back to zones with heads installed as pool may become too cloudy to see the floor.

- Clear all suction plugs and let pumps run without the module in place for at least ten minutes.
- Install module in water valve. Be sure to tap the band clamp when placing it around the lid on the water valve.
- Let the valve cycle normally through all zones on the pool.
- Lay out the pool plan on the deck.
- Check the pool plan for the correct nozzle location.
- Lay all the heads on the deck of the pool closest to their prospective locations.
- Review the pool plan to determine the EXACT SIZE ORIFICE for each nozzle and place orifices in nozzles.
- Blow out the debris by placing the Vanquish tool on top of the body. Allow flow to the zone to move on to the next zone then install the nozzle in the body. Water flowing out of the lines during installation may cause the o-ring to come off.
- Starting at the shallow end of the pool after the zone cycles install the top nozzle first. If there is more than one nozzle on the zone flush the transfer line between all other nozzles, installing one nozzle at a time. Once you have finished with one zone, proceed to the next zone, following the water valve as it cycles. Install each nozzle after the valve has cycled past and lines are clear of any debris.
- When all nozzles have been installed, check the pressure of each zone on the water valve. The pressure at each zone should be about the same.
- Install all of the down jets adjusting them to direct water down the wall of the pool.
- Adjust MAIN DRAIN LINE by setting the valve at the pump so the skimmer just begins to skim.
- Verify final pressure at the water valve and double check fixed adjustment.

TROUBLE SHOOTING

If the pressure is below 14 psi on all of the circuits

Read the gauge pressure on the top of the water valve or valves. The pressure reading should be 14 to 25 psi on each of the circuits. The pressure decreases for a short time while the valve is switching ports.

- Clean the filter.
- Check the pump sizing.
- If there is a heater, make sure that it has a bypass on it.
- Check accessory lines like Parascope
- Check for obstructions between the pump and the water valve such as venturi for ozone or chlorine feeders.
- Check to see if one zone of nozzle (s) is staying up all the time. If a zone of nozzle(s) is stuck up, remove the module and wash by dipping in the pool or a bucket of water. Use a hose if you are careful not to spray high-pressure water into the module. Spraying high-pressure water into the module may unseat the diaphragm

<p>If the pressure is high or low on one or more circuits</p>	<ul style="list-style-type: none"> • Check the nozzles on the circuits that are low for installation of the correct orifice; if there are two (2) nozzles on the line, they should have 1/2" orifices in them. • If the pressure is high on any of the circuits. Check that line for rocks or other construction debris. Check that line for the correct nozzle size. 1 nozzle on a line = (1) 3/4" 2 nozzle on a line = (2) 1/2"
<p>ONE OR MORE CLEANING NOZZLES REMAIN UP WHILE FLOW CONTINUES TO OTHER CIRCUITS</p>	<ul style="list-style-type: none"> • Lightly depress nozzle, with pressure on that nozzle, to discharge any particles between the nozzle and body. • Remove, if necessary, and clean nozzle and inner body (check for plaster or debris). • Damaged piston assembly in water valve. Replace the Module.
<p>CLEANING NOZZLE POPS UP BUT DOES NOT CLEAN</p>	<ul style="list-style-type: none"> • Debris is lodged in nozzle. Remove and clean, allowing the valve to cycle through at least two (2) times before reinserting the nozzle assembly.
<p>VALVE DOES NOT CYCLE</p>	<ul style="list-style-type: none"> • Control knob on dome pause phase. • Check turbine shaft for restricted movement. • Valve gears not meshing.
<p>VALVE CYCLES - BUT MORE THAN ONE CIRCUIT OF NOZZLES REMAINS UP</p>	<ul style="list-style-type: none"> • Check for glue or debris on top surface of ribs (portion of lower base that meets bottom of valve module), clean off glue or debris. • Check for debris lodged between shut-off plate seat and valve poppet. • Check for debris lodged in between floor nozzles and body, depressing nozzle with pole to dislodge debris. • Displaced or ruptured piston assembly.
<p>CLEANING NOZZLE WILL NOT POP UP Paramount pool and spa systems request that any current problems with the valve module be directed to the home office, or send the valve module directly to paramount for inspection and/or repair. (RMA required for return)</p>	<ul style="list-style-type: none"> • Check for clogged line. • Water valve module not rotating.
<p>CLEANING NOZZLE POPS UP BUT WILL NOT ROTATE</p>	<ul style="list-style-type: none"> • Lightly depress nozzle, with pressure on that nozzle, to dislodge any particles between body and nozzle. • If necessary, remove nozzle assembly and clean inner body and outer nozzle surface.
<p>CLEANING NOZZLES FLOATING</p>	<ul style="list-style-type: none"> • Service the valve module.

WATER VALVE PART NUMBERS

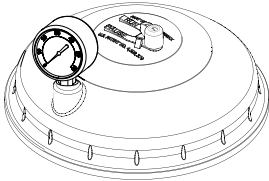

005-302-3590-00
Pressure Gauge

005-302-3502-00
Pause Assembly
Includes: Screw Knob, O-Ring & Pawl



005-302-4300-03
Top Dome Complete
Includes: Top, Gauge & Pause Assembly

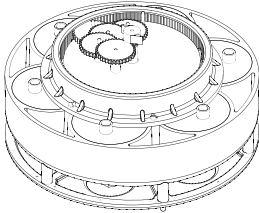

Modules:
004-302-4400-00 2 Port 4 Gear
004-302-4402-00 2 Port 5 Gear
004-302-4404-00 3 Port
004-302-4406-00 4 Port
004-302-4408-00 6 Port

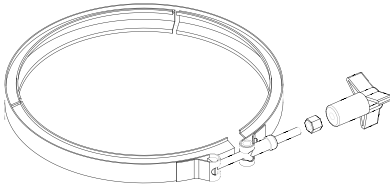

005-302-3570-00
Band Clamp (Complete)
Includes Knob & Nut

005-302-3600-00
Band Clamp Knob

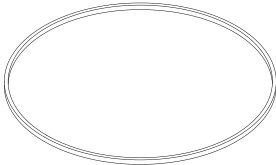

005-302-0640-00
Band Clamp Nut

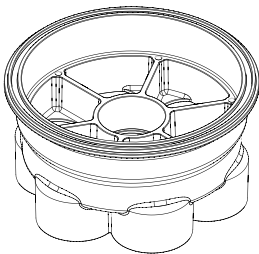

005-302-0100-00
Base O-Ring

Valve Base (US)*:
005-302-4002-03 2 Port Base 2" Black
005-302-4012-03 3 Port Base 2" Black
005-302-4018-03 4 Port Base 2" Black
005-302-4032-03 6 Port Base 2" Black

Valve Base (Metric):
005-302-4006-03 2 Port Base 63 mm Black
005-302-4019-03 3 Port Base 63 mm Black
005-302-4020-03 4 Port Base 63 mm Black
005-302-4033-03 6 Port Base 63 mm Black

*US 2" is equivalent to Australian 50 mm.

VANQUISH PART NUMBERS

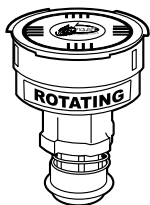

004-577-5020-xx
Vanquish Rotating Nozzle (includes Nozzle Jet Inserts)

005-577-3630-00
Vanquish Rotating Nozzle Replacement Stem & Spring

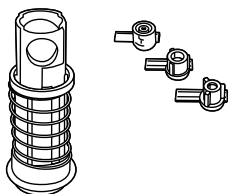

005-577-5600-00
Nozzle Jet Inserts 1/8", 1/4", 3/8"

005-577-5602-00
Nozzle Jet Inserts 1/4", 3/8", 1/2"

005-577-0816-00
Body Ring Top Screws (10 pieces)

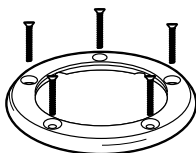

005-577-4830-XX
Vanquish Body Ring Top

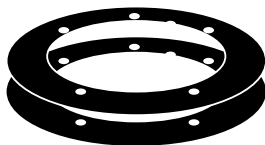

005-577-0040-00
Body Gasket Set (1 ea)

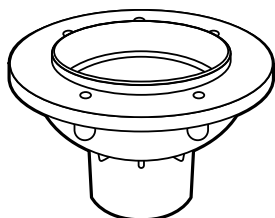

004-577-4740-XX
Vanquish Body

005-577-1124-00
Vanquish Body Cap (6 pieces)

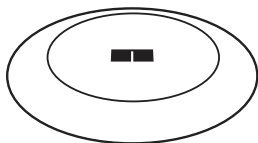

005-577-5440-00
Vanquish Nozzle Tool, Plastic Handle

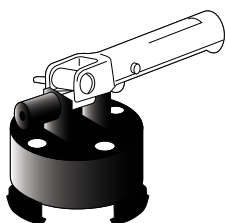

Indicate color choice by placing the appropriate color code in place of the "XX" at the end of the part number.

White-01

Gray-02

Black-03

Blue-05

Light Gray-08